

**AD ORACLE**  
FUME EXTRACTION UNIT

OPERATIONAL INSTRUCTIONS

CE

# TABLE OF CONTENTS

|   |           |
|---|-----------|
| <b>SAFETY INSTRUCTIONS</b> .....                    | <b>3</b>  |
| <i>Symbols used</i> .....                           | 3         |
| <i>Electrical safety</i> .....                      | 3         |
| <i>Dangers to eyes, breathing and skin</i> .....    | 3         |
| <i>Warning and Information Labels</i> .....         | 4         |
| <b>INSTALLATION</b> .....                           | <b>5</b>  |
| <i>Introduction</i> .....                           | 5         |
| <i>Fume Capture Methods</i> .....                   | 5         |
| <i>Arm and nozzle extraction</i> .....              | 5         |
| <i>Enclosures</i> .....                             | 6         |
| <i>Cabinets</i> .....                               | 6         |
| <i>Extractor Overview</i> .....                     | 7         |
| <i>Extractor Installation Procedure</i> .....       | 8         |
| <i>Optional Feature Considerations</i> .....        | 8         |
| <i>Filter blocked/System failure signal</i> .....   | 9         |
| <i>Remote stop/start</i> .....                      | 9         |
| <i>Compressor</i> .....                             | 10        |
| <i>Electrical supply connection</i> .....           | 10        |
| <i>General Safety Requirements</i> .....            | 10        |
| <b>OPERATION</b> .....                              | <b>11</b> |
| <i>Manual operation</i> .....                       | 11        |
| <i>Gas Filter Change LED (VOC monitoring)</i> ..... | 12        |
| <i>Closed Loop Auto Flow Control</i> .....          | 12        |
| <i>Setting the Airflow</i> .....                    | 12        |
| <b>MAINTENANCE</b> .....                            | <b>13</b> |
| <i>Maintenance UK</i> .....                         | 13        |
| <i>Maintenance General</i> .....                    | 13        |
| <i>Cleaning Unit</i> .....                          | 13        |
| <i>Replacing Filters</i> .....                      | 13        |
| <i>Filter replacement indication</i> .....          | 14        |
| <i>Pre filter replacement</i> .....                 | 14        |
| <i>Combined filter replacement</i> .....            | 15        |
| <i>Consumable Spares</i> .....                      | 15        |
| <i>Maintenance Protocol</i> .....                   | 15        |
| <i>Fuses</i> .....                                  | 16        |
| <i>Filter Disposal</i> .....                        | 16        |
| <b>TROUBLE SHOOTING</b> .....                       | <b>17</b> |
| <b>SYSTEM SPECIFICATIONS</b> .....                  | <b>18</b> |
| <i>Unit: AD Oracle</i> .....                        | 18        |

## SAFETY INSTRUCTIONS

### Symbols used



**Danger** Refers to an immediately impending danger. If the danger is not avoided, it could result in death or severe (crippling) injury. Please consult the manual where this symbol is displayed.



**Warning** Refers to a possibly dangerous situation. If it is not avoided, it could result in death or severe injury. Please consult the manual where this symbol is displayed.

**Caution** Refers to a possibly harmful situation. If it is not avoided, damage could be caused to the product or to something in its environment.

**Important** Refers to handling tips and other particularly useful information. This does not signify a dangerous or harmful situation.

### Electrical safety

The AD range of extraction units are designed to meet the safety requirements of the Low Voltage Directive 2006/95/EC (previously numbered 73/23/EEC) and UL61010-1.



**Warning** During works with the pump/motor housing open, live, 230/115 volt components are accessible. Make sure that rules and regulations for work on live components are always observed.

**Important** To reduce the risk of fire, electric shock or injury:

1. Always isolate the system from the mains power supply before removing the pump/motor panel.
2. Use only as described in the manual.
3. Connect to a properly grounded outlet.





### Dangers to eyes, breathing and skin

Once used, the filters in the AD range of extraction units contain a mixture of particulates, some of which may be sub micron size. When the used filters are moved it may agitate some of this particulate, which could get into the breathing zone and eyes of the operative. Additionally, depending on the materials being lasered, the particulate may be an irritant to the skin.

**Caution: When changing used filters always wear mask, safety glasses and gloves.**

Please note the media in the gas filter fitted in this unit is capable of adsorbing a wide range of organic compounds. However, it is the responsibility of the user to ensure it is suitable for the particular application it is being used on.

## Warning and Information Labels

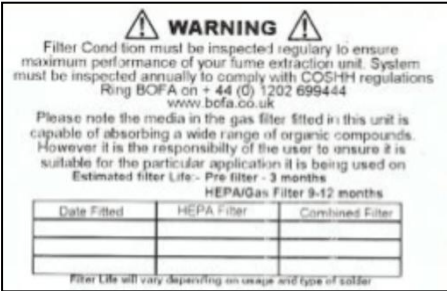
| Label/Symbol  | Position  |                 |                 |  |  |  |  |  |  |  |  |  |  |
|---|---|-----------------|-----------------|--|--|--|--|--|--|--|--|--|--|
|  <p><b>WARNING</b><br/>GOGGLES, GLOVES &amp; MASK<br/>MUST BE WORN WHEN<br/>CHANGING FILTERS</p> <p>Please note the media in the gas filter fitted in this unit is capable of absorbing a wide range of organic compounds. However it is the responsibility of the user to ensure it is suitable for the particular application it is being used on.</p>   | <p>Pump / motor across panel inside door, central.</p>    |                 |                 |  |  |  |  |  |  |  |  |  |  |
|  <p><b>Danger</b><br/>Disconnect the<br/>mains supply before<br/>removing this cover</p>   | <p>Pump/motor access panel<br/>Inside door top corner</p> |                 |                 |  |  |  |  |  |  |  |  |  |  |
|  <p><b>DO NOT COVER</b></p>   | <p>Rear of unit above louvers</p>                         |                 |                 |  |  |  |  |  |  |  |  |  |  |
|  <p><b>BOFA</b><br/>INTERNATIONAL LTD</p> <p>Bofa International Ltd<br/>21-22 Balena Close<br/>Creekmoor Industrial Estate<br/>Poole, Dorset<br/>BH17 7DX<br/>Tel: +44 (0)1202 699444<br/>Fax: +44 (0)1202 699446<br/>www.bofa.co.uk</p> <p>Model: AD-Oracle<br/>Serial No. ORACLE-XXX</p> <p>115-230V, 12.5A, 50/60 Hz</p> <p><b>WARNING</b><br/>THIS EQUIPMENT MUST BE EARTHED<br/>MANUFACTURED<br/>2006 05</p> <p> <b>UL LISTED</b><br/>Laboratory Equipment<br/>3308</p>  | <p>Side of unit, next to cables</p>                       |                 |                 |  |  |  |  |  |  |  |  |  |  |
|  <p><b>WARNING</b></p> <p>Filter Condition must be inspected regularly to ensure maximum performance of your fume extraction unit. System must be inspected annually to comply with COSHH regulations. Ring BOFA on + 44 (0) 1202 699444 www.bofa.co.uk</p> <p>Please note the media in the gas filter fitted in this unit is capable of absorbing a wide range of organic compounds. However it is the responsibility of the user to ensure it is suitable for the particular application it is being used on</p> <p>Estimated filter Life - Pre filter - 3 months<br/>HEPA/Gas Filter 9-12 months</p> <table border="1" data-bbox="328 1861 703 1939"> <thead> <tr> <th>Date Fitted</th> <th>HEPA Filter</th> <th>Combined Filter</th> </tr> </thead> <tbody> <tr> <td> </td> <td> </td> <td> </td> </tr> <tr> <td> </td> <td> </td> <td> </td> </tr> <tr> <td> </td> <td> </td> <td> </td> </tr> </tbody> </table> <p>Filter Life will vary depending on usage and type of solder</p> | Date Fitted   | HEPA Filter     | Combined Filter |  |  |  |  |  |  |  |  |  | <p>Pump / motor across panel inside door, central.</p> |
| Date Fitted   | HEPA Filter   | Combined Filter |                 |  |  |  |  |  |  |  |  |  |  |
|   |   |                 |                 |  |  |  |  |  |  |  |  |  |  |
|   |   |                 |                 |  |  |  |  |  |  |  |  |  |  |
|   |   |                 |                 |  |  |  |  |  |  |  |  |  |  |

# INSTALLATION

## Introduction

When a component is laser marked an amount of the surface of the substance is thermally decomposed, “burnt off”. This thermal decomposition comprises a mixture of particulate and gaseous compounds. The heat energy causes the gases and surrounding air to quickly expand moving away from the surface at high velocity entraining any particulate with the gases. This is the fume.

There are two main reasons for capturing the fume:

- 1 Operational – if ignored the fume can settle on the laser optics causing damage to the lens and impairing the quality of the marking.
- 2 Health and Safety – The particulate generated from most materials is sub micron size which is a health hazard if inhaled and some materials give off harmful gases which again operators need protecting from.

The AD range of units are suitable for extracting the fume from laser marking applications, capturing it in the multistage filter system and returning the associated clean air back into the workplace.

## Fume Capture Methods

The fume is normally captured by one of three methods: a flexible arm and nozzle close to the marking point, an enclosure around the marking area, or from the cabinet the laser is housed in.

### Arm and nozzle extraction

For most applications, the product to be marked on a conveyor will move past the stationary laser. The nozzle should be positioned as close as possible to the marking area on the side of the laser the product is moving towards. (See fig. 1)

Hose Kit (see fig. 2)

The stay put arm should be mounted as close as possible to the marking point using the horseshoe clips. Unscrew the push fit connector from the other end of the flexible hose. Cut the flexible hose to suit the distance back to the extractor connection, keeping it as short as practicable, then refit the connector and push onto the extractor inlet.

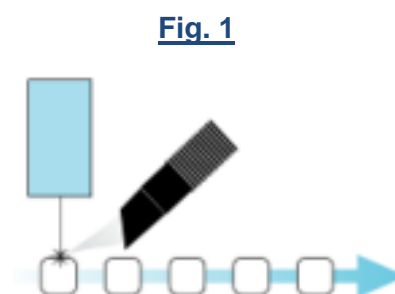

Purge air should be kept to a minimum, where possible, to prevent the fume being blown away from the nozzle.

High speed bottling lines may need bigger scoops or nozzles both sides of the bottles because of the turbulence caused by the speed of the bottles.

**Fig. 2**



**Fig. 3**

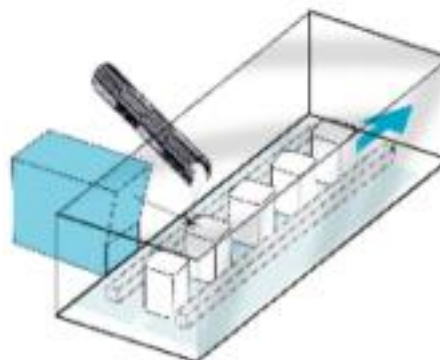

## Enclosures

Extraction can be attached to an enclosure around the marking zone provided the extraction point is situated within 50 -75mm of the marking point.  
(See fig. 3)

## Cabinets

(See fig. 4) Cabinets normally have a 75 or 100mm spigot for fume extraction. For best performance use the same diameter hose as the spigot and reduce at extractor if necessary. Keep the hose run as short as possible.

**Extraction units should be sited in a well ventilated room.**

**Fig. 4**

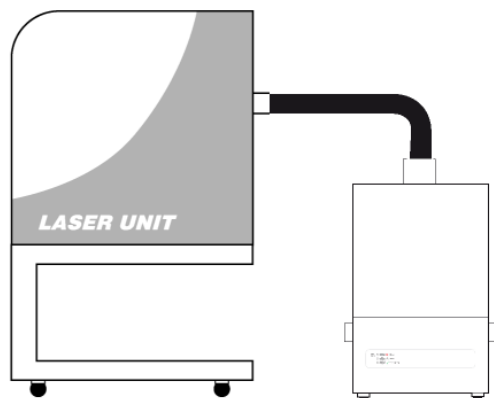

## Extractor Overview

The AD range provides extraction and filtration of the fume generated by laser marking, cutting, etching or engraving. The units are of robust design and feature ease of use with minimal maintenance. The main components are shown in Fig. 5.

**Fig. 5**

1. Unit / Filter Condition Display – Auto Flow Control
2. On / Off Switch
3. Power Cable
4. Signal / Interface Cable to Laser
5. Filter Housing Cam Latch
6. Door Hinge
7. Hose Inlet Connection
8. Extracted Air Outlet
9. Motor Cooling In/Out

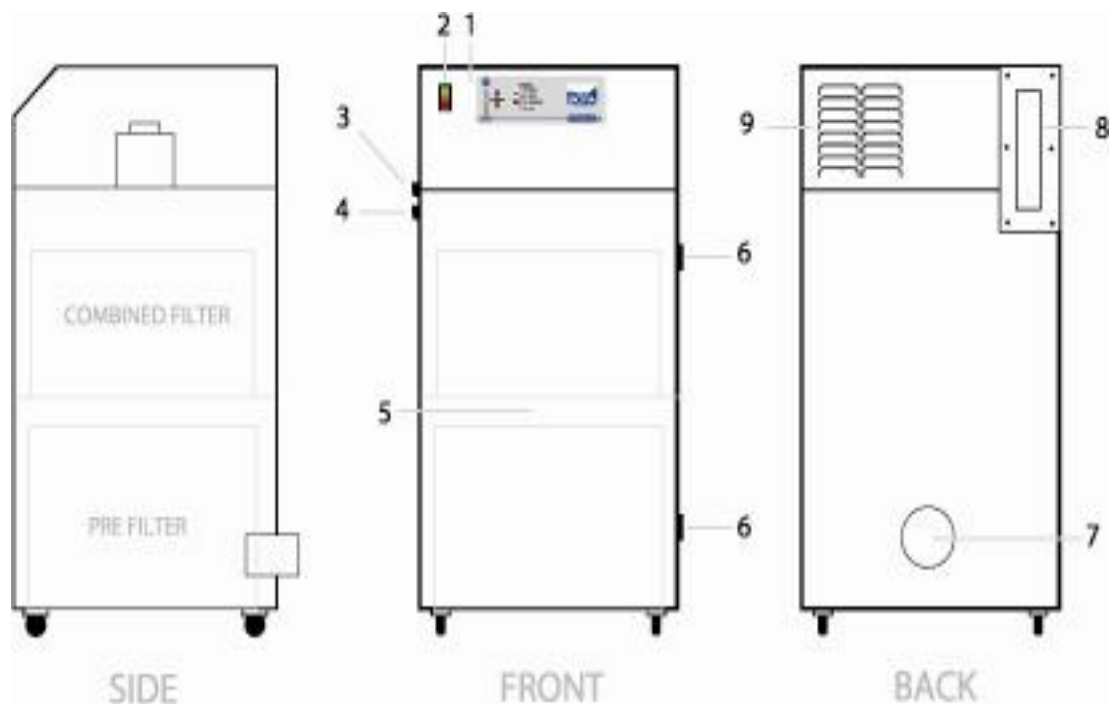

---

## **Extractor Installation Procedure**

### **Caution**

If this equipment is used in a manner not specified by the manufacturer, the protection provided by the equipment may be impaired.

Read all instructions in this manual before using this extractor.

1. Move the unit to the location where it is going to be installed and remove the unit from its packaging. The unit should be installed in a well ventilated room.

### **Caution**

Due to the weight involved the extractor unit should only be lifted using suitable lifting equipment and with regard to appropriate safety precautions. (See Appendix for product weight details).

2. Ensure that a 0.5m space is available around any louvered areas of the unit to ensure adequate air flow. Lock the two braked castors, if fitted.

### **Caution**

Do not block or cover the cooling vents on the unit, as this severely restricts airflow and may cause damage to the unit. (This may be located on the base of the unit).

### **Caution**

Under no circumstances should the exhaust outlet/s be covered as this will restrict the airflow and cause overheating.

3. Check filters are located in their correct position and carefully replace lid/close door.

4. Connect the extraction ducting between the extractor inlet and the fume capture device as detailed previously.

### **Optional Feature Considerations**

5. If fitted, the following features need to be considered when installing the unit:



## Important

If the AD unit has an exhaust air outlet spigot fitted, the exhausted air can be routed outside of the building if required. It is important to keep any ducting used to do so to a minimum, in order to reduce back pressure within the system.

## Filter blocked/System failure signal

With this option the extraction unit will have been fitted with a pressure transducer to monitor the condition of the filters and to indicate the extractor is running. In addition to controlling the LED's on the front of the unit, this signal is available via the green and white cores of the control cable that exits the cabinet next to the power cable. The signal is a "volt free" contact, i.e. a closed circuit will exist between the green and white wires when the filter condition is good and the unit is running. This will change to an open circuit on filter blockage or system failure. This feature should only be used on control voltage circuits. The signal can be connected to the laser or alternatively to operate a beacon, siren or warning device. Open circuit condition of this circuit will not directly stop the extractor motor.

## Remote stop/start

If this facility is installed it enables the extractor unit to be turned on and off by a signal from the laser. The red and black cores of the control cable need to be connected to a 5 – 30v ac or dc supply, which when applied will start the unit and when switched off will stop the unit. However the mains power switch must be in the "on" position for the signal to be effective.

**Fig 6**



If fitted, remote operation can be overridden by using the override switch, which is mounted inside the unit (see fig. 7).

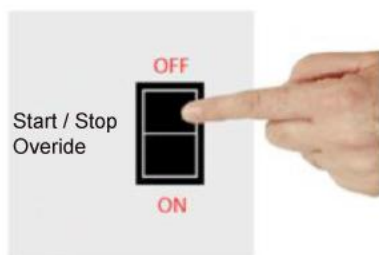

**Fig 7**

## Compressor

If the optional compressor is fitted, connect the compressed air line between the laser and the extractor. Ensure that any water trap/ filter unit in use is situated nearest to the laser (and not the extractor). The arrows (indicating air flow) on the side of the water trap/filter should be pointing in the direction of the airflow (i.e. air into the laser Unit).

## Electrical supply connection

6. Check the integrity of the electrical power cable. Connect the power cable to an isolated electrical supply. The mains socket outlet should be installed near the equipment and be easily accessible. The cable run to the machine should be arranged so as not to create a trip hazard.

### Caution:

Check that the mains input at the isolated supply is the same as the voltage Supply detail on the Serial Number label (**115 - 230v 50/60Hz**) before plugging the extractor unit in.

## General Safety Requirements

The mains socket outlet should be installed near the equipment and be easily accessible.

### Caution

Do not block or cover the cooling vents on the unit, as this severely restricts airflow and may cause damage to the unit. (This may be located on the base of the unit).

### Caution

This unit is over 18Kgs in weight and should only be lifted with suitable lifting equipment.

### Caution

If this equipment is used in a manner not specified by the manufacturer, the protection provided by the equipment may be impaired.

Read all instructions in this manual before using this extractor.



### Warning

**Mains voltage. Dangerous voltages exist in this equipment.  
Ensure all covers are fitted before operating this equipment.**

The unit is now ready for use.

## OPERATION

### Manual operation

Stainless steel AD units are turned on by depressing the green button on the front of the extractor and turned off by depressing the red button. See fig 8. Powder coated AD units are turned on and off by means of a green, illuminated rocker switch on the front of the unit. (See Fig 9).

**Fig 8 Stainless Steel Units**



**Fig 9 Powder coated Units**



**Note:** In order to help ensure long term reliability of the fan unit, it is recommended that a 90 second delay period (minimum) is observed between stopping and restarting the extractor to prevent possible damage to electronic components within the fan.

### Filter condition and System failure signal - indicators

The LED's on the front panel (see table and fig 10 below) indicate the following conditions

| LED'S | SHOWING                     | INDICATES  |
|-------|-----------------------------|--|
|       | Green Only                  | Unit is running - Filters are usable   |
|       | Green & Amber               | Pre or Combined Filter 75% blocked   |
|       | Green, Amber & Red          | Pre or Combined Filter Blocked and in need of replacing                      |
|       | Green, Amber & Red flashing | Fault with extractor. This condition may occur for a few seconds on start up |
|       | Red Alarm Light             | Only used with optional extra Gas Filter Change LED                          |

Filter change procedures are explained in Section 5 'Maintenance'.

## Gas Filter Change LED (VOC monitoring)

Units equipped with a VOC sensor detect the level of Volatile Organic Compounds in the exhausted air. If their presence exceeds a preset level the Alarm LED on the front panel will illuminate. This indicates that the gas portion of the combined filter is saturated and the filter needs replacing. See fig 10. The Maintenance section describes the filter change procedure.

**Fig 10**

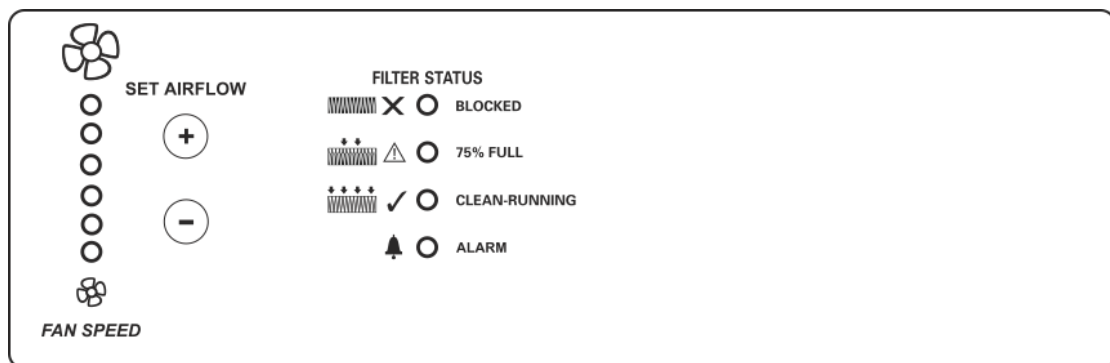

## Closed Loop Auto Flow Control

With this fitted the unit features closed loop automatic flow control. This enables you to set the required airflow rate. When filters start to block, the blowers in the extractor will increase in speed compensating for any loss in performance. The extractor must be fully installed, with all pipe work connected before setting the airflow.

## Setting the Airflow

To set the airflow on your extractor, hold down the Up (+) and Down (-) arrows on the front panel for 5 seconds. (See fig 8) The green LED will now start to flash, indicating that the machine is now in set mode. You can now increase or decrease the flow by holding down either the up or down arrow. The flow is indicated by a row of 6 blue LED's on the panel, 6 being full speed and 1 being the lowest. Set the airflow on the lowest of the 6 LED's but still ensure that all of the fume is being removed. This will vary from application to application. Once you have set your speed, leave the controls for 10-20 seconds and the machine will return to operation mode. (This setup procedure should be carried out with all the ductwork connected and (if fitted) the stop/start signal present)

## MAINTENANCE

---

### Maintenance UK

It is a legal requirement, under regulation 9 of the COSHH regulations, that all local exhaust ventilation systems are visually inspected on a weekly basis, where possible and undergo a thorough inspection and test on an annual basis.

COSHH requires the annual inspection and testing to be carried out by a competent person with specific documentation of the results held in a log book. Bofa can provide this service, our inspectors are BOHS P601 qualified, and copies of the required initial information and forms are included in the Log book supplied with the extractor. Additionally the log book contains a form detailing the weekly inspection requirements and log for recording the results.

### Maintenance General

User maintenance is limited to cleaning the unit and replacing the filters with new. Only BOFA International trained maintenance technicians are authorised to carry out component testing and replacement. Unauthorised work or the use of unauthorised replacement filters may result in a potentially dangerous situation and/or damage to the extractor unit, and will invalidate the manufacturer's warranty.

### Cleaning Unit

The powder coated finish can be cleaned with a damp cloth and non aggressive detergent. Do not use an abrasive cleaning product as this will damage the finish. Stainless steel units should be cleaned with a proprietary stainless steel cleaner, following the manufacturer's instructions.

The cooling inlets and outlets should be cleaned once a year to prevent build up of dust and overheating of unit.

### Replacing Filters

The filter package needs attention when the filter change signal is alarmed and/or the green amber and red LED's on the unit are illuminated or, for units with no filter condition indication, when the unit no longer removes the fume efficiently.

A log of filter changes should be maintained by the user.

All filters are tested to BS3928. A certificate on conformity for each filter is available on request.

It is recommended that a spare set of filters are kept on site to avoid prolonged unit unavailability. Part numbers for replacement filters can be found on the filters fitted in your system. Alternatively, refer to the consumable spares table.

### Caution

To prevent overheating, units should not be run with a blocked filter condition, or with dust obstruction of inlets or outlets.

**Caution: When changing used filters always wear mask, safety glasses and gloves.**

### **Filter replacement indication**

The first few filter changes should only apply to the pre-filter. The indication that the Combined filter needs replacing is when the filter alarm signal and LED's (if fitted) do not go off after the pre filter has been changed.

If the VOC monitor option is fitted, the requirement for a combined filter change is indicated by illumination of the Gas filter alarm light on the front panel.

**Please note** that the carbon media within the combined filter is hygroscopic and will absorb moisture from the atmosphere. This is why these filters should be changed every twelve months regardless.

### **Pre filter replacement**

The pre filter needs changing when the filter change signal is alarmed and/or the green amber and red LED's on the unit are illuminated (if option fitted).

1. Isolate the electrical supply to the extractor.
2. Undo the two catches on the front of the unit and open the door.
3. The pre filter is the lower of the two filters (see Fig 11). Using the handle, on the front of the filter, pull it out of the unit being careful to support it as it comes free as it is heavy.
4. Slide a clean filter back into position making sure it is pushed all the way in to locate on the spigot at the back of the unit.
5. Close the door and fasten the two latches.
6. Reconnect the electrical supply.

**Fig. 11**

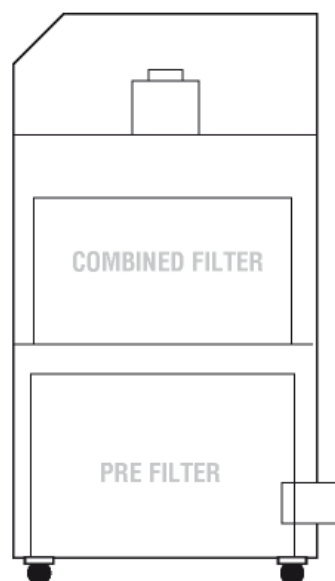



## Fuses

The following table gives details of the internal fuses in the AD range of units:

| Unit      | Item Protected | Fuse Rating A | FLC A | Voltage     |
|-----------|----------------|---------------|-------|-------------|
| AD ORACLE | 12v Power Pack | 1             | <.1   | 110v - 230v |

## Filter Disposal

Pre and combined filters are manufactured from non-toxic materials. Filters are not re-usable, cleaning used filters is not recommended. Disposal of the used filters depends on the material deposited on them. See the following table:

| Deposit       | EWC listing* | Comment  |
|---------------|--------------|--|
| Non Hazardous | 15 02 03     | Can be disposed of as non hazardous waste.   |
| Hazardous     | 15 02 02 M   | The type of Hazard needs to be identified and the associated risks defined. The thresholds for these risks can then be compared with the amount of material in the filters to see if they fall into the hazardous category. If so, the filters will need to be disposed of inline with the local/national regulations. |

\* European Waste Catalogue



## TROUBLE SHOOTING

---

In the unlikely event of a problem with your AD extractor please contact your local representative.

OR

### **BOFA International Ltd**

21-22 Balena Close,  
Creekmoor Industrial Estate,  
Poole, Dorset BH17 7DX, UK

Tel: +44 (0)1202 699444

Fax: +44 (0)1202 699446

Email: [technical@bofa.co.uk](mailto:technical@bofa.co.uk)

Website: [www.bofa.co.uk](http://www.bofa.co.uk)

OR

### **Bofa Americas, Inc**

Bofa Americas Inc.  
303 S. Madison Street  
Staunton, Illinois 62088  
USA

Tel: (618)-635-4465

Fax: (866) 707-2632 (BOFA)

Email: [info@bofaamericas.com](mailto:info@bofaamericas.com)

Website: [www.bofaamericas.com](http://www.bofaamericas.com)

## SYSTEM SPECIFICATIONS

### Unit: AD Oracle

|                    |  |                  |                     |
|--------------------|--|------------------|---------------------|
| Capacity:          | 380 m <sup>3</sup> /hr (224cfm)  |                  |                     |
| Size:              | height 980mm x depth 430mm x width 430mm<br>(height 38.6"x depth 16.9"x width 16.9") |                  |                     |
| Weight:            | 75Kg (165 lbs)   |                  |                     |
| Exhauster:         | Centrifugal Fan  |                  |                     |
| Output:            | 1.1kw  |                  |                     |
| Electrical supply: | 115 - 230v 1ph 50Hz / 60Hz   |                  |                     |
| FLC:               | 12.5A  |                  |                     |
| Noise level:       | Below 60dB (A)<br>(At Normal operating speed)  |                  |                     |
| Filters:           | Pre filter   | Surface area     | 12.0 m <sup>2</sup> |
| Efficiency F8      | 85% @ 0.8μ   |                  |                     |
| Combined:          | HEPA filter  | Efficiency H13   | 99.997% @ 0.3μ      |
|                    |  | Surface Area     | 3.0m <sup>2</sup>   |
|                    | Gas filter   | Activated Carbon | 15kg                |

### Environmental Operating Range

|             |   |
|-------------|---|
| Temperature | +5°C to +40°C                                   |
| Humidity    | Max 80 % RH up to 31°C<br>To Max 50% RH at 40°C |